

2016



AIKU comes from the Japanese word “haiku” and it means a short poem generally composed of three verses. Wonderful poems that in a few words express remarkable meanings; a simple poem, with no lexical frills and conjunctions, taking its strength from suggestions. Due to its incredible shortness, it requires a considerable synthesis of thought and image.

The meaning and the sound of this word reveal the project’s concept, to reconcile the paradoxes of uses and sensitiveness. AIKU can be radical, but at the same time is a refined architecture designed for domestic environments, as well as offices and public spaces.

A collection of highly comfortable chairs featuring an essential image, designed for both home and contract spaces. Available in six versions of bases and a wide range of finishes.

Shell

Shell made from two-colour polypropylene through injection-moulding, mass pigmented with double finish; gloss outside, in black and white colours, inside with matt saffiano effect in different colours.

Gloss white external shell, inside:

- light grey
- sugar paper blue
- olive green
- dove grey

Gloss black external shell, inside:

- dark grey
- military green

Bases

The lacquered bases (white and black matt) are supplied in the same colour of the shell’s external finish. In addition, the new chromed base is now available for both shells.

Bases available:

- 4-legged round-shaped base in steel tube, painted matt white, matt graphite grey or chrome-plated;
- sled base in steel wire, painted matt white, matt graphite grey or chrome-plated;
- sled base in steel wire with armrests, painted matt white, matt graphite grey or chrome-plated;
- sled base in steel wire with armrests and table, painted matt white, matt graphite grey or chrome-plated. HPL 10mm thick table arm available in matt white or matt black;
- 4-legged tapered base with injection-moulded tube in rectangular section, painted matt white, matt graphite grey or chrome-plated;
- 4-legged base in solid oak with a natural, bleached or brown finish.

Versions with 4-legged round-shaped base, sled bases and 4-legged tapered base are stackable

Accessories:

- **Trolley:**
aluminium grey epoxy painted steel frame, with pirouetting castors matching the frame; maximum capacity 15 pieces. For specifications and sizes, see page 5.7 of the pricelist.
- **Hook for Sled base:**
dedicated hooking system for seat alignment, made of stiff PA6 plastic, in the colours white and black. For specifications and sizes, see page 5.8 of the pricelist.
- **Hook for 4-legged base:**
dedicated hooking system for seat alignment, made of stiff PA6 plastic, in the colours white and black. For specifications and sizes, see page 5.8 of the pricelist.
- **Place marker:**
dedicated numbering system with magnet hook, in stiff PA6 plastic, in the colours white and black. For 4-legged round-shaped base and sled base. For number definition, lead time and feasibility, please contact our Sales Department. For specifications and sizes, see page 5.8 of the pricelist.
- **Padded Pad:**
Thermoformed cushion, size 47.8 x 43.5 cm, 1.5 cm thick, with BS flame-retardant polyurethane padding and combined with welded fabric; non-slip PES-PU coat underneath. This technical manufacturing detail enhances both graphics and padding with a 3D effect, ensuring quality and a long lasting product. Considering the special features, the cover is not removable.

Cushion available with LONDRA fabric cover in the colours white col. 01 and black col. 07. For fabric specifications, see Section 8 of the collection’s pricelist.

Package contains 2 pieces.

VERSIONS

STACKABILITY

4-legged round-shaped base

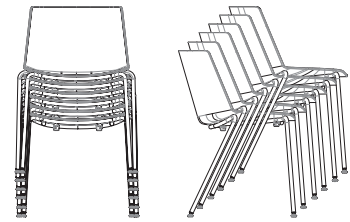

X 6

sled base

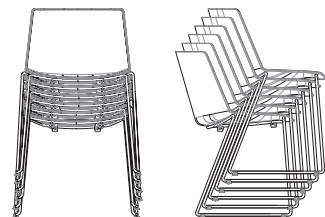

X 6

sled base with armrests

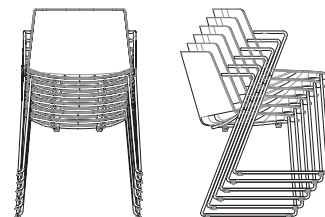
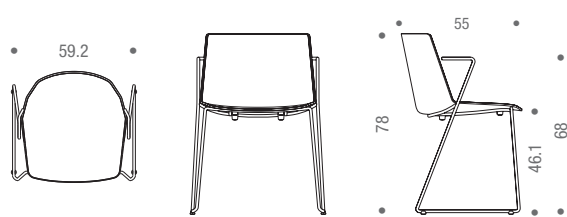

X 6

sled base with table

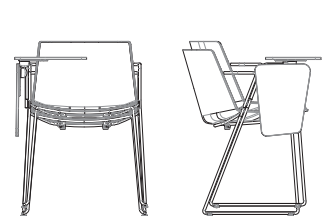
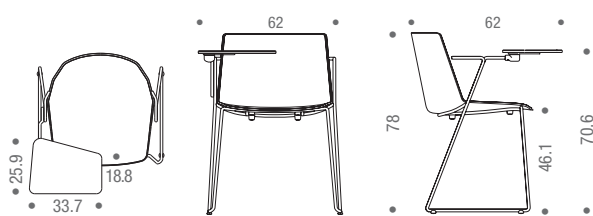

X 2

4-legged tapered base

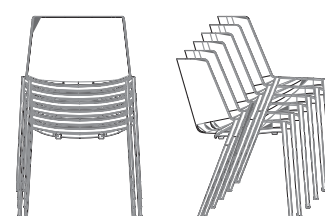
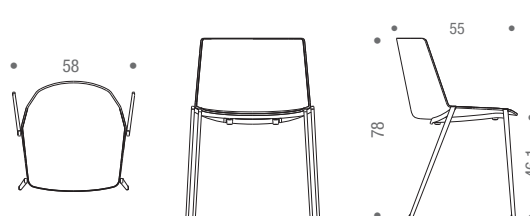

X 6

4-legged oak base



WHITE EXTERNAL FINISH

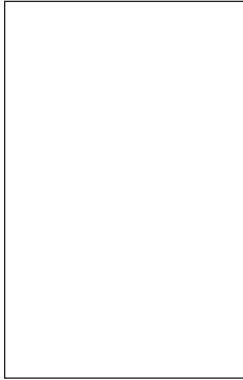

INSIDE FINISH



sugar paper blue X087



olive green X088



light grey X089



dove grey X090

BLACK EXTERNAL FINISH



INSIDE FINISH

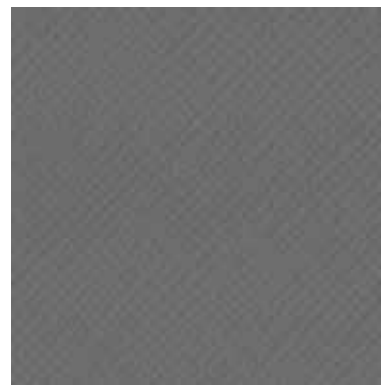

dark grey X091



military green X092

TROLLEY (max 15 pcs)

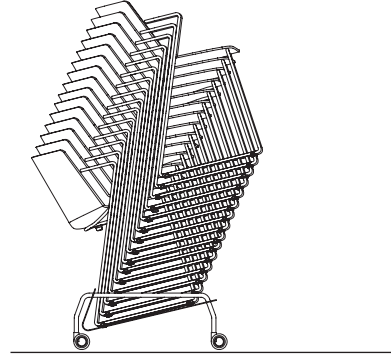
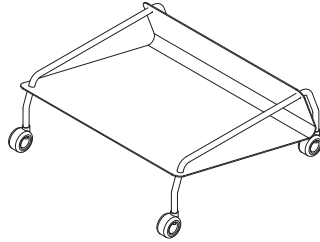
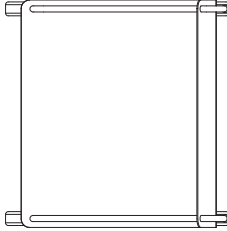
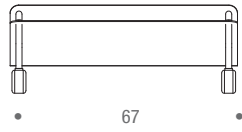
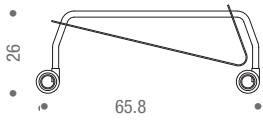

PADDED PAD

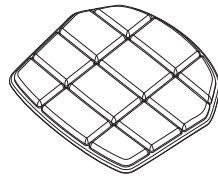
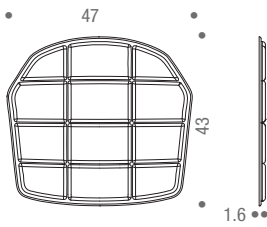

MARKER
for 4-legged round-shaped base and sled base

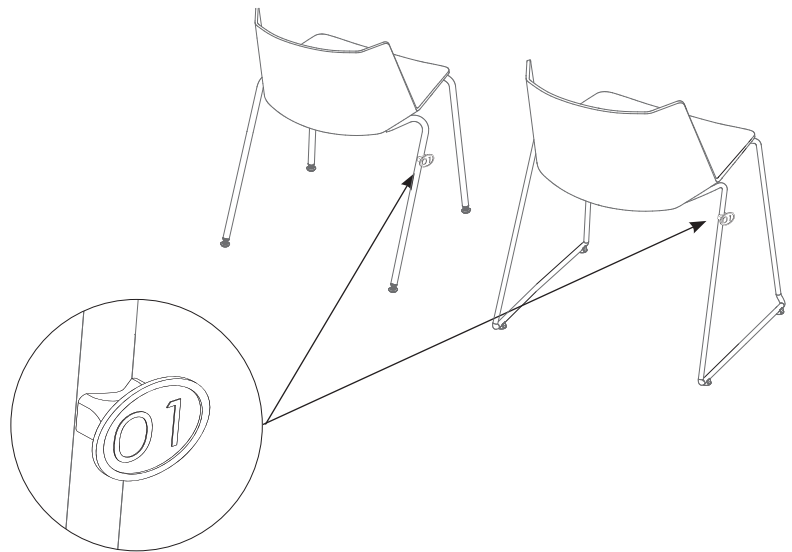
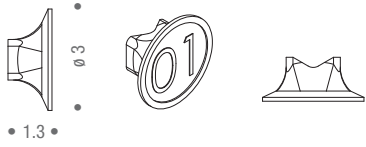

HOOK FOR SLED BASE

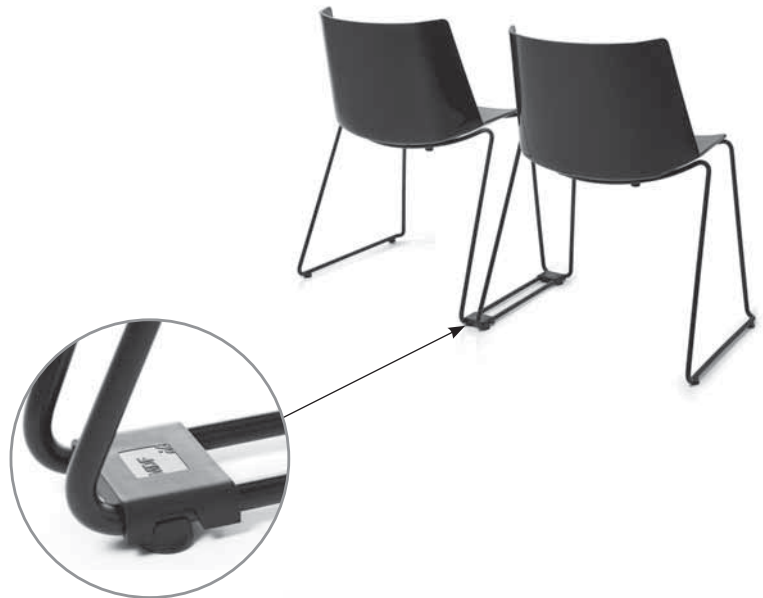
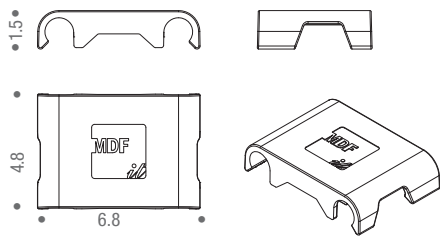

HOOK FOR 4-LEGGED BASE

