

- INSTRUCTION MANUAL -

ARCS SHADE

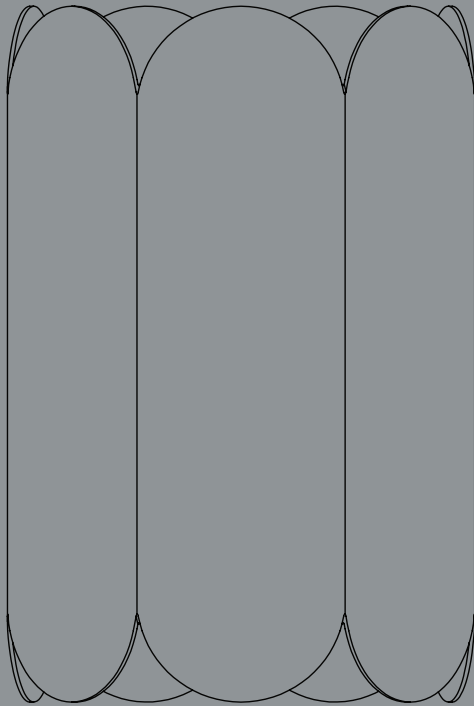

DESIGN BY MULLER VAN SEVEREN

HAY

- GENERAL INFORMATION -

TECHNICAL DATA

This product is designed to be used in conjunction with the HAY Cord Set/Cord Set Table, or a similar cord set. HAY recommends using this product with a LED bulb.

FITTING TYPE | LED E27

POWER (W) | 10-15W

COLOUR TEMPERATURE | Warm white

HAY will not accept any responsibility for any accidents, injuries or damages that occur due to the use of incorrect bulbs.

ATTENTION

Ensure that the power supply to the circuit has clearly been turned OFF before installing the product. In some countries, electrical installation must be carried out by authorised electricians/contractors; please check with your local authority for guidance.

The product must not be modified in any way. HAY accepts no responsibility for any products that have been modified or tampered with. This lamp is designed for indoor use only.

NOTE | The cord sets for the lamps are sold separately and are available in two designs – a table/floor variant with an in-line rocker switch, and a pendant variant for ceiling lamps. Both variants are not supplied with a bulb. If you are using this shade in conjunction with a HAY Cord set, please follow the instructions that have been provided with it for safe installation.

- The Arcs Shade is designed to be used with LED based light sources only.

CARE AND MAINTENANCE

The product can be cleaned with a soft damp cloth and mild detergent, or a dry microfibre cloth. Do not use alcohol or any other solvents to clean the product and avoid using abrasive or rough sponges. Ensure that the power supply has been turned OFF before cleaning the product.

- PARTS -

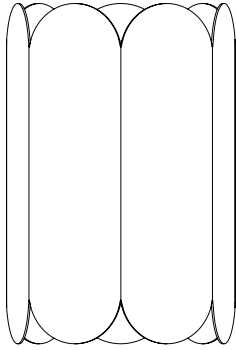

Shade

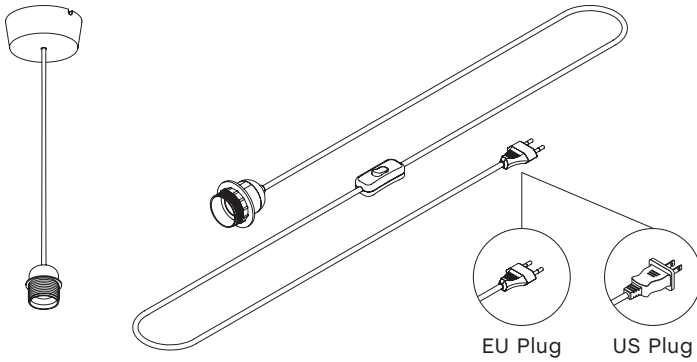

Cord Sets (not included)



LED Bulb (not included)

1.

Unpack all the parts and check that you have received all the parts listed. Unscrew and remove the ring from the bulb holder of your chosen cord set.

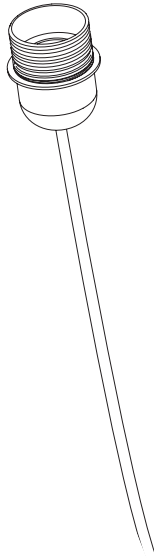

2.

Place the shade over the bulb holder with the bottom of the base facing downwards.

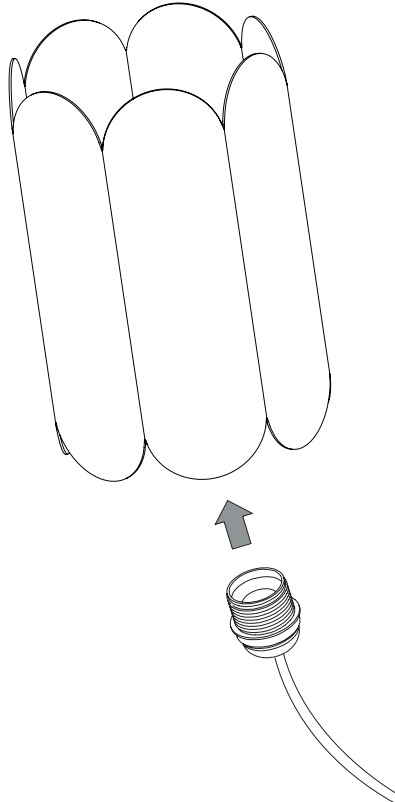

3.

Insert the bulb holder through the central hole in the base plate and clamp it in place by screwing the ring back onto the bulb holder. Take care to fasten the ring securely, especially if you are using the shade with the pendant cord set.

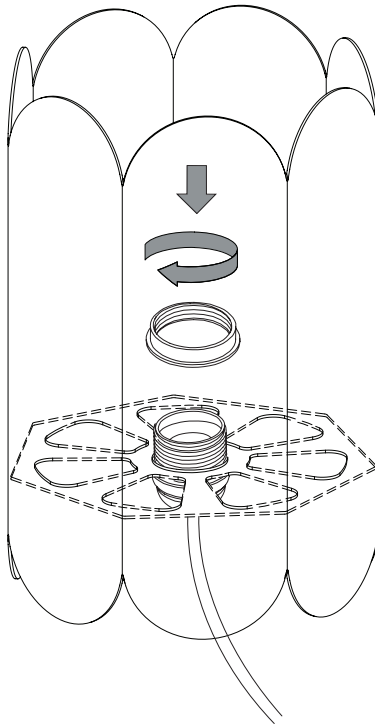

4.

Screw an LED light bulb into the bulb holder.
Ensure the electricity is switched off before fitting the bulb to avoid damaging it.

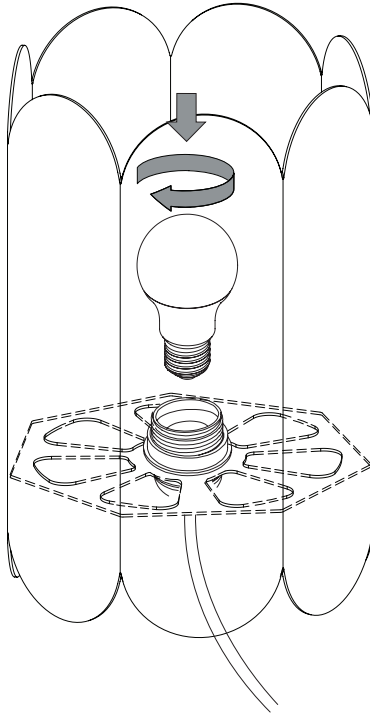

5.

The Arcs Shade is now ready for use.

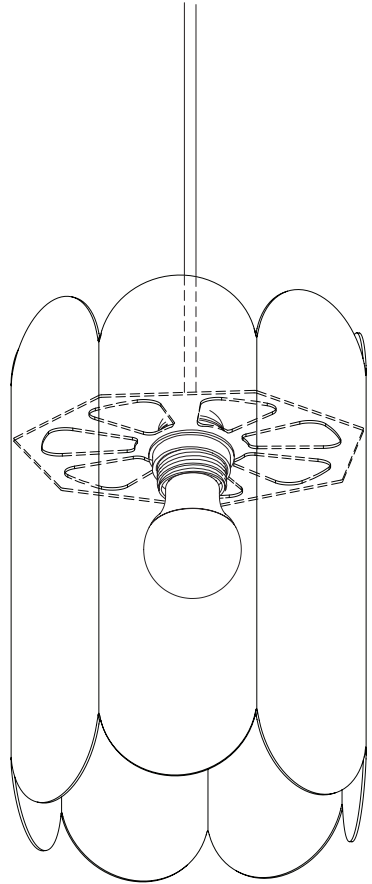
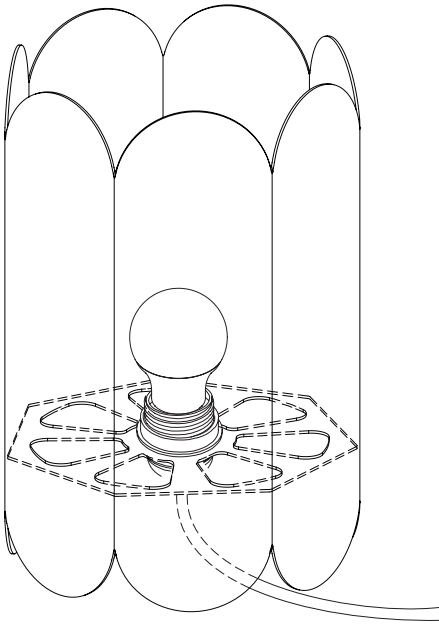

- CARE & MAINTENANCE -

Our Care & Maintenance offers guidance for optimal maintenance of your HAY product. It includes advice and instructions on cleaning and caring for specific materials to prolong the life of your lighting.



Please find our Care & Maintenance guide by scanning the QR code



You can find more relevant information on Arcs Shade by scanning the QR code

You can also find the same information here
hay.dk/downloads

Havnen 1 8700 Horsens Denmark
+45 4282 0282 / hay@hay.com

www.hay.com

06/12/2021

HAY