

PRODUCT FACT SHEET

VISU WOODBASE CHAIR FURNITURE / LIGHTING / ACCESSORIES

Mika Tolvanen on the design "The task was to create a personal interpretation of the ever-relevant plywood chair. I wanted my chair to have an unobtrusive and timeless nature that is familiar but never boring and without sacrificing function or ergonomics. Designing a family of chairs, visually related but for different functions, was an interactive and thorough process lasting nearly two years. In the end, I think every detail is exactly as it is supposed to be."

PROCESS	Shell is formpressed from wood veneer, then lacquered. If specified, then padded with fire-resitant foam and fully upholstered with textile. Wood base is formpressed in veneer. Upholstered versions with textiles from Kvadrat or leather from Camo.
DESIGNED BY / YEAR OF DESIGN	Mika Tolvanen / 2012
TYPE	Chair
DESCRIPTION	Chair for private or professional interiors available in a range of colours and as well as textile upholstery. Also available with sled base and tube base.
ENVIRONMENT	Indoor
DIMENSIONS (CM)	Height: 78,5 Seat height: 46 Width: 46 Seat width: 42,5 Depth: 51 Seat depth: 40
MATERIAL	Lacquered ash or oak veneer shell, formpressed wood veneer base. Wood is PU lacquered.
COLOUR	Wood shell: Oak, white/oak, black, grey, red, green, dusty green, rose
STANDARD UPHOLSTERIES	Textile: Black/ Field 142, Oak/ Field 232, Oak/ Field 932, Grey/ Steelcut Trio 133, Oak/ Steelcut Trio 515, Black/ Steelcut Trio 195 Leather: Black/Black Silk leather, Oak/Cognac Silk leather Other fabric types for projects available on requests.
CLEANING INSTRUCTIONS	Use moist cloth first, then wipe off excess liquid with dry cloth. For upholstery versions, please find specific cleaning instructions for your chosen textile at www.kvadrat.dk or for leather at www.ca-mo.com
TESTS & CERTIFICATION	Danish Technological Institute - EN 16139 L2. Tested to withstand level 2: Extreme use. Tested to withstand use in areas where the furniture is occasionally or repeatedly subject to extremely high loads. i.e. Nightclubs, railway stations, transport terminals.
SPARE PARTS	Comes with standard glides.
ABOUT THE DESIGNER	Mika Tolvanen is part of the Finnish Rehti Design group. After graduating from the Royal College of Art with a Master in design in 2001, Mika established his own design office in Helsinki. Since then he has worked with some of the world's top designers and manufacturers.

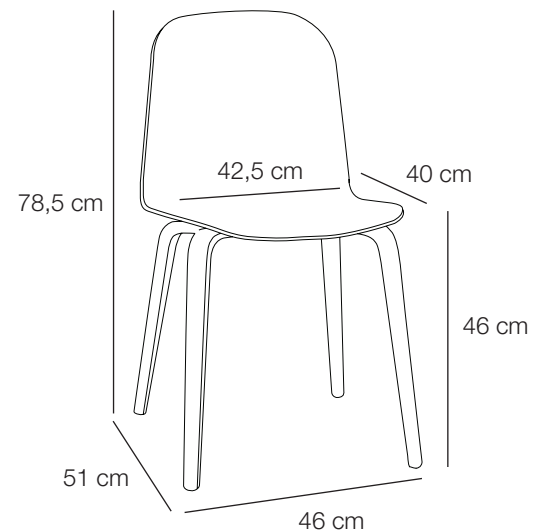





























PRODUCT FACT SHEET

VISU WOOD/SLEDBASE CHAIR FURNITURE / LIGHTING / ACCESSORIES

Standard colours & textiles Other colours or Steelcut Trio textiles are available at a 5% extra cost. Other textiles available upon request.

Colour

Wood shell 	 Grey	 Dusty green	 Green	 Black	 Rose	 Red	 White	 Oak	 Yellow
Wood base 	 Grey	 Dusty green	 Green	 Black	 Rose	 Red	 Oak	 Oak	
Sled base 	 Grey		 Green	 Black	 Rose	 Red	 White	 Stainless steel	 Yellow

Upholstery versions

Upholstered shell 	 Field 132	 Field 142	 Field 232	 Field 932	 Steelcut Trio 133	 Steelcut Trio 515	 Steelcut Trio 195	 Steelcut 190	 Black Silk leather	 Cognac Silk leather
Wood base 		 Black	 Oak	 Oak	 Grey	 Oak		 Black	 Black	 Oak
Sled base 	 Black	 Black			 Grey		 Black		 Black	 Stainless steel