

m o o o i<sup>®</sup>



## Zio Lounge Chair

---

Lean back, close your eyes, relax your arms on the smooth armrests and grant yourself the time to drift your imagination away, beyond your surroundings, into the street, beyond the starry night. Living your fantasies is easy while cosily sitting in the solid softness of Marcel Wanders' Zio lounge chair!â

---

**Designer**

Marcel Wanders

**Year of design**

2013

**Material**

Solid oak frame

---

---

## colours



Wood Stained  
Cinnamon



Wood Stained  
White Washed

Zio lounge chair, dining chair, dining table and coffee tables are also available in a composition of Cinnamon and White Washed stained oak.



Composition



Composition



Composition

---

## packaging

### Zio Lounge Chair

H 86 cm | 33,9"  
W 83 cm | 32,7"  
D 83 cm | 32,7"

Colli 1/1

With packaging:  
15 KG | 33,1 lb

### Zio Footstool

H 41 cm | 16,1"  
W 59 cm | 23,2"  
D 59 cm | 23,2"

Colli 1/1

With packaging:  
10 KG | 22 lb

---

## cleaning instructions

Moooi recommends using a good furniture polish and a soft cloth. Apply generously in layers to the surface and use the cloth to shine. Do not use abrasive fabrics, gently remove tough stains with warm water and a trusted multi-surface cleaner.

---

## upholstery categories

Tartanic  
Macchedil Sottile  
Macchedil Grezzo  
Oray  
Manga  
Faux

Bouclé  
Jacquard Andaz  
Jacquard Fresco  
Jacquard Old Blue  
Arredo Leather  
Cervino Leather

---

## Tartanic

### composition

64% VI / 27% CO / 9% PA



---

## Macchedil, Sottile

### composition

49% vi, 24% pl, 21% li, 6% co

### abrasion

30.000 martindale

### lightfastness 4

### firetest

FR BS5852 0/1

EN1021 I&2



Macchedil Sottile  
**Black indigo**



Macchedil Sottile  
**Pinkish**



Macchedil Sottile  
**Off white**



Macchedil Sottile  
**Light grey**



Macchedil Sottile  
**Light brown**



Macchedil Sottile  
**Grey grey**



Macchedil Sottile  
**Anthracite**



Macchedil Sottile  
**Blue grey**



Macchedil Sottile  
**Cappucino**



Macchedil Sottile  
**Deep blue**

## Macchedil, Grezzo

**composition**

47% co, 20% vi, 18% pi, 8% li, 5% pc, 2% af

**abrasion**

18.000 martindale

**lightfastness 4**

**firetest**

FR BS5852 0/1

EN1021 I&2



## Manga

**composition**

29% pl, 71% co

**abrasion**

40.000 martindale

**lightfastness 5**

**firetest**

FR BS5852 0/1

EN1021 I&2



## Oray

### composition

8% co, 38% vi, 15% pl, 39% li

### abrasion

25.000 martindale

### lightfastness 4

### firetest

FR BS5852 0/1

EN1021 I&2



Oray  
**Cream**



Oray  
**Sand**



Oray  
**Rock**



Oray  
**Mineral**



Oray  
**Gravel**

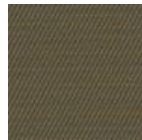

Oray  
**Dark Gull**



Oray  
**Copper**

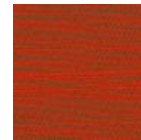

Oray  
**Rust**



Oray  
**Flamboyant**



Oray  
**Oil**

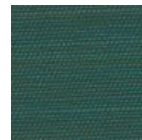

Oray  
**Aqua**

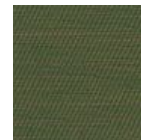

Oray  
**Peyote**



Oray  
**Ocean**



Oray  
**Metal**



Oray  
**Griffin**

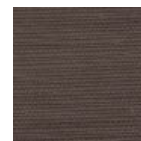

Oray  
**Dusk**



Oray  
**Chestnut**

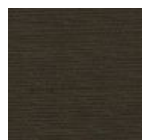

Oray  
**Dark**



Oray  
**Indigo**



Oray  
**Ochre**

---

## Faux

### composition

100% pl

### abrasion

50.000 martindale

### lightfastness 4

### firetest

FR BS5852 0/1

EN1021 I&2



Faux  
**Black**

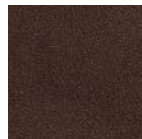

Faux  
**Brown**

---

## Bouclé

### composition

43% co, 28% pan, 14% pa, 12% vi, 3% pl

### abrasion

20.000> martindale

### lightfastness 4

### firetest

FR BS5852 0/1

EN1021 I&2

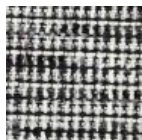

Bouclé  
**Black white**

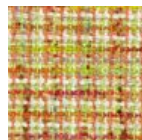

Bouclé  
**Rainbow**



Bouclé  
**Brown**

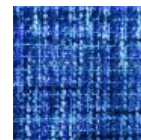

Bouclé  
**Blue**

---

## Jacquard andaz

**composition:**

34% cotton - 30% viscose - 24% linen - 12% polyamide

**abrasion:**

25000 martindale

**firetest:**

BS 5852 : Part 1 : 1979

BS EN 1021 1&2



Jacquard  
**Andaz**

---

## Jacquard Old Black & Blue

**composition**

52% vi, 38% co, 10% li

**abrasion**

20.000> martindale

**firetest**

FR BS5852 0/1

EN1021 1&2



Jacquard  
**Old Blue**

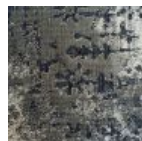

Jacquard  
**Old Black**

---

## Jaquard Fresco

### composition

40% vi ,36% co,14% pl, 10% li

### abrasion

20.000> martindale

### firetest

FR BS5852 0/1

EN1021 1&2



Jaquard  
**Fresco**

---

## Arredo Leather

### composition

100% semi aniline leather

### firetest

FR BS5852 0/1

EN1021 1&2

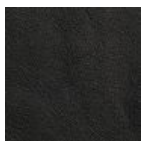

Arredo Leather  
**Black**

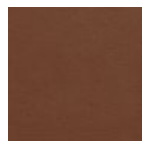

Arredo Leather  
**Brown**



Arredo Leather  
**White**



## dimensions

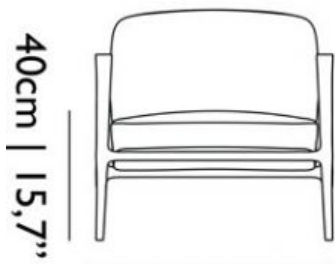
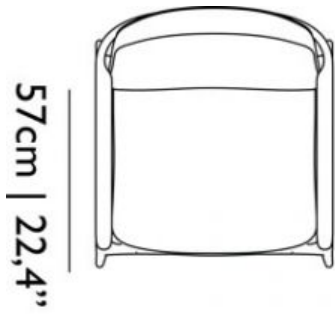

77cm | 30,3"



85cm | 33,5"

